

MYTIME

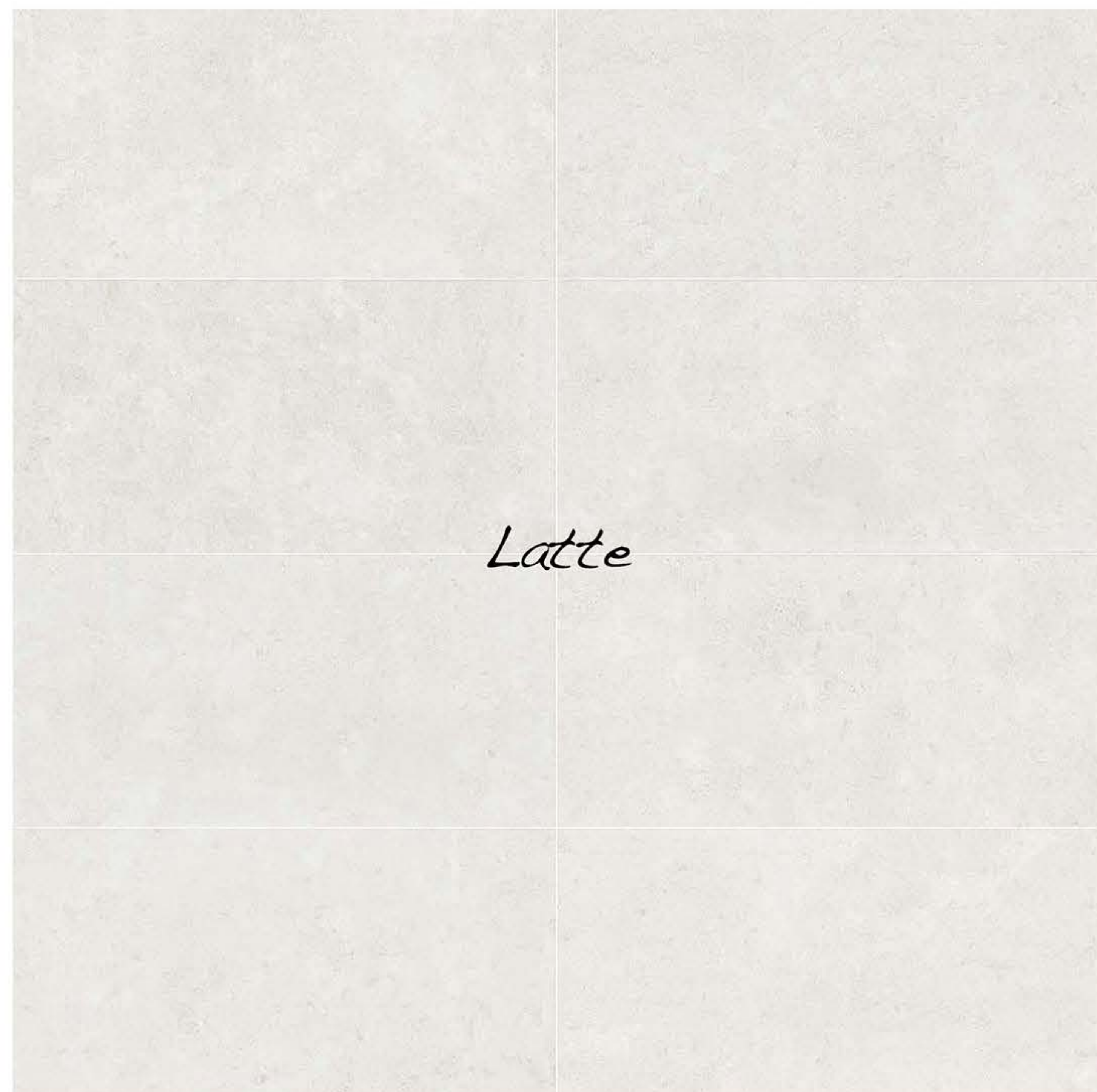

Latte

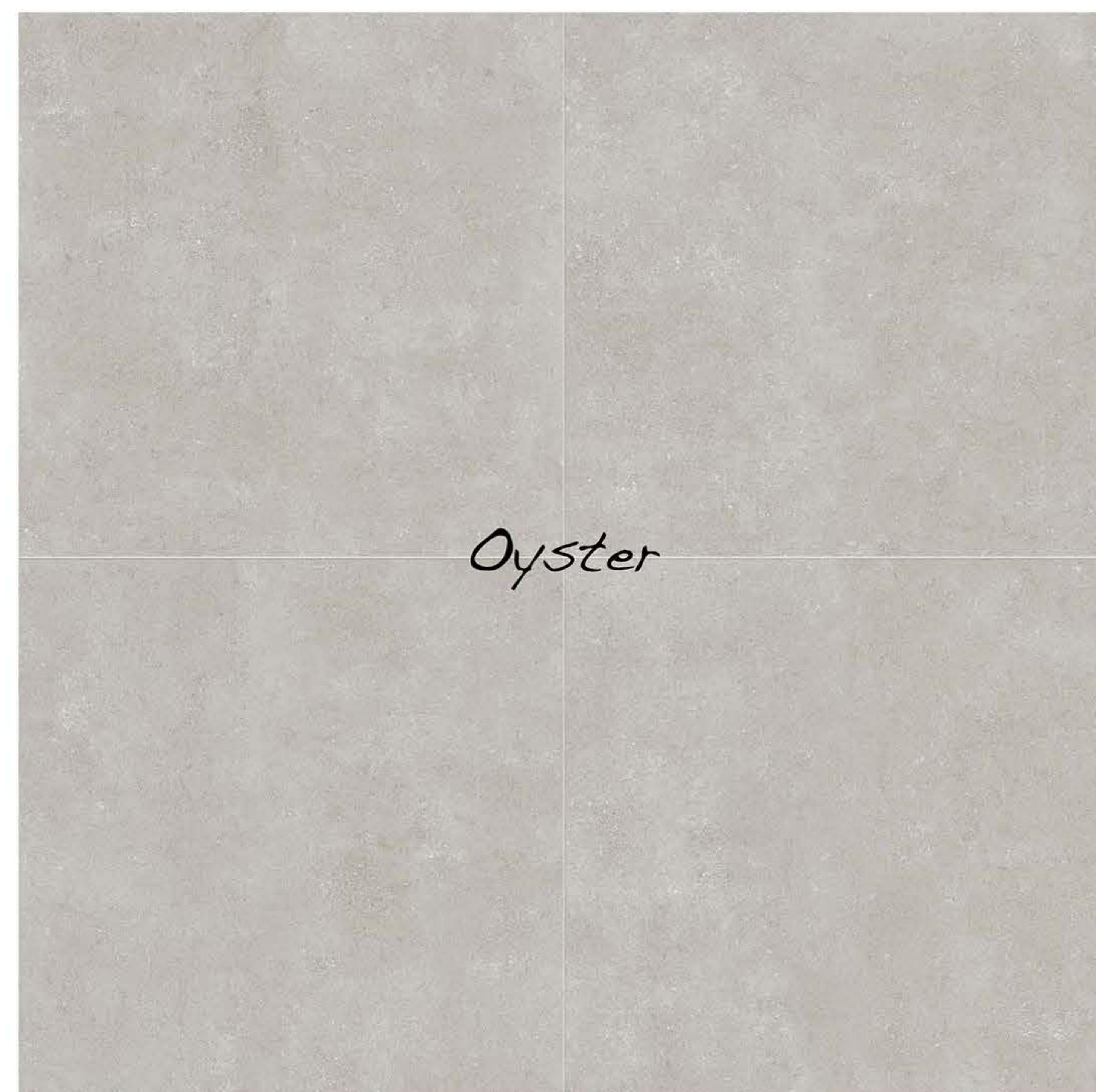

Oyster

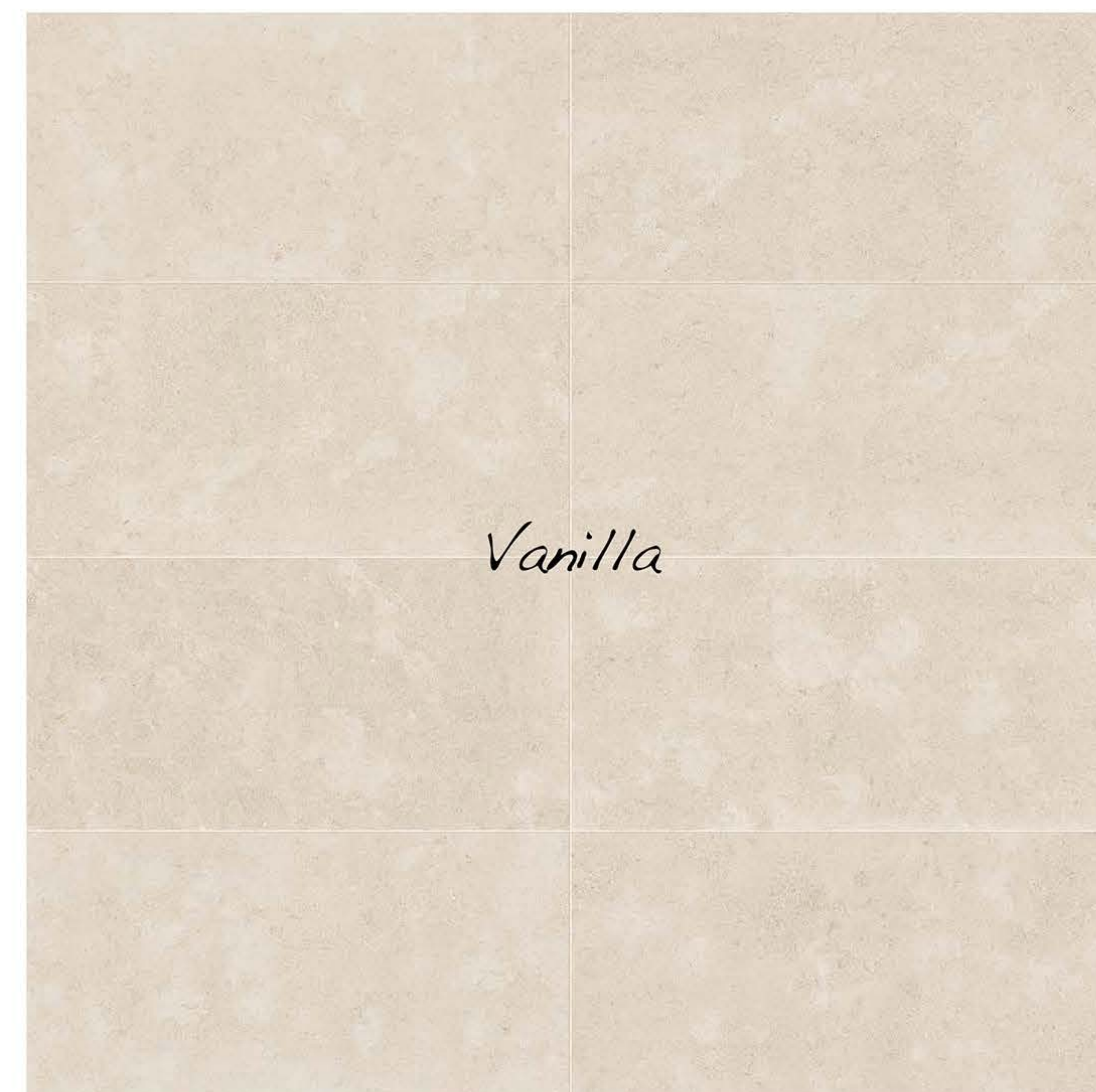

Vanilla

MYTIME

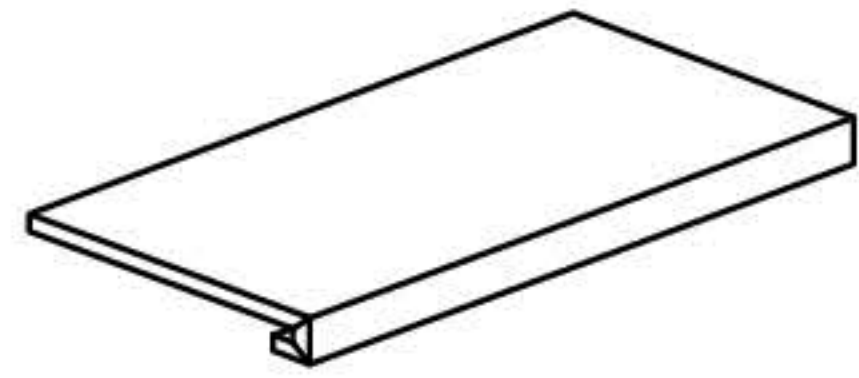

± 9 MM
GRADINO 30X60 (12"X24") ① ★
8Q50 LATTE
8Q49 VANILLA
8Q48 CAMEL
8Q47 OYSTER

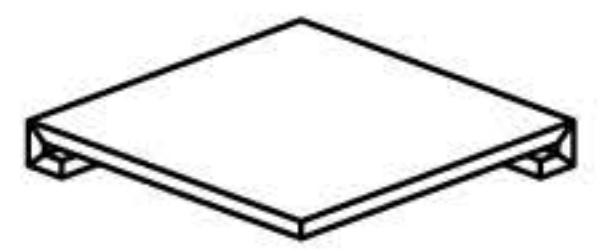

± 9 MM
ANG. GRADINO 30X30 (12"X12") ① ★
3PQ1 LATTE
3PQ4 VANILLA
3PQ5 CAMEL
3PQ6 OYSTER

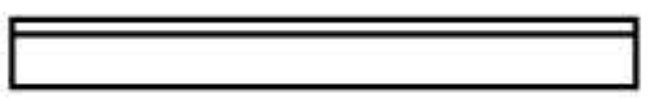

± 9 MM
BATTISCOPA 7X60 (3"X24")
5W88 LATTE
5W87 VANILLA
5W86 CAMEL
5W85 OYSTER

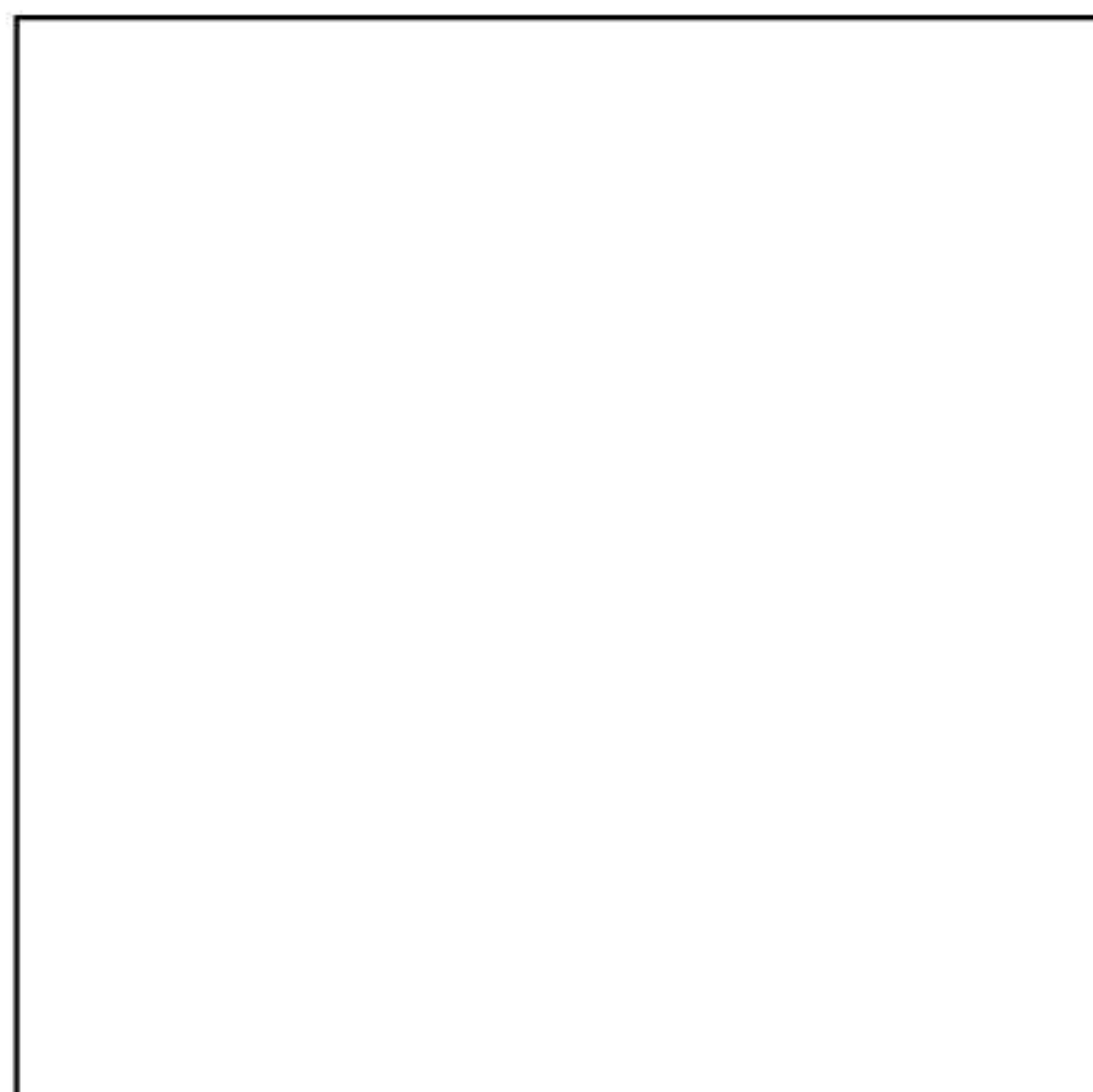

± 9 MM
120X120 (48"X48") RET
1FT6 LATTE
1FT7 VANILLA
1FT8 CAMEL
1FT9 OYSTER



± 9 MM
60X120 (24"X48") RET
4C64 LATTE
4C65 VANILLA
4C66 CAMEL
4C62 OYSTER

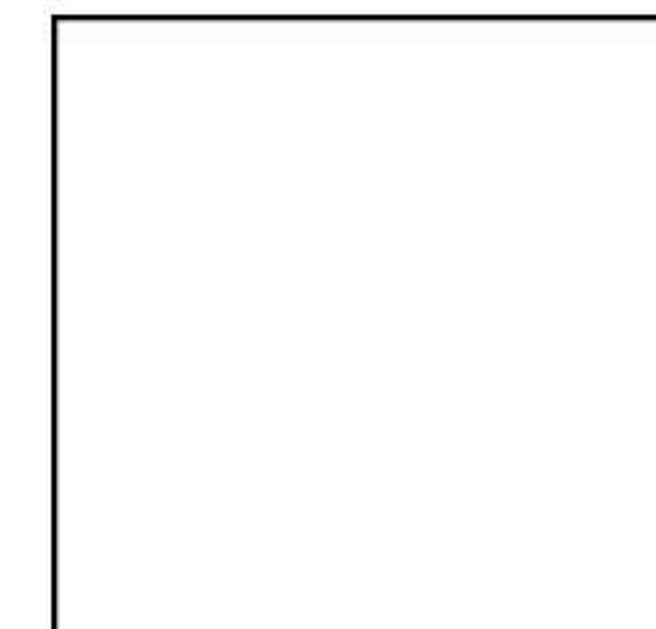

± 9 MM
60X120 (24"X48") ANTISLIP
4C74 LATTE
4C88 VANILLA
4C40 CAMEL
4C68 OYSTER



± 9 MM
60X60 (24"X24") RET
7W88 LATTE
7W87 VANILLA
7W86 CAMEL
7W85 OYSTER



± 9 MM
60X60 (24"X24") ANTISLIP
7W84 LATTE
7W83 VANILLA
7W66 CAMEL
7W65 OYSTER

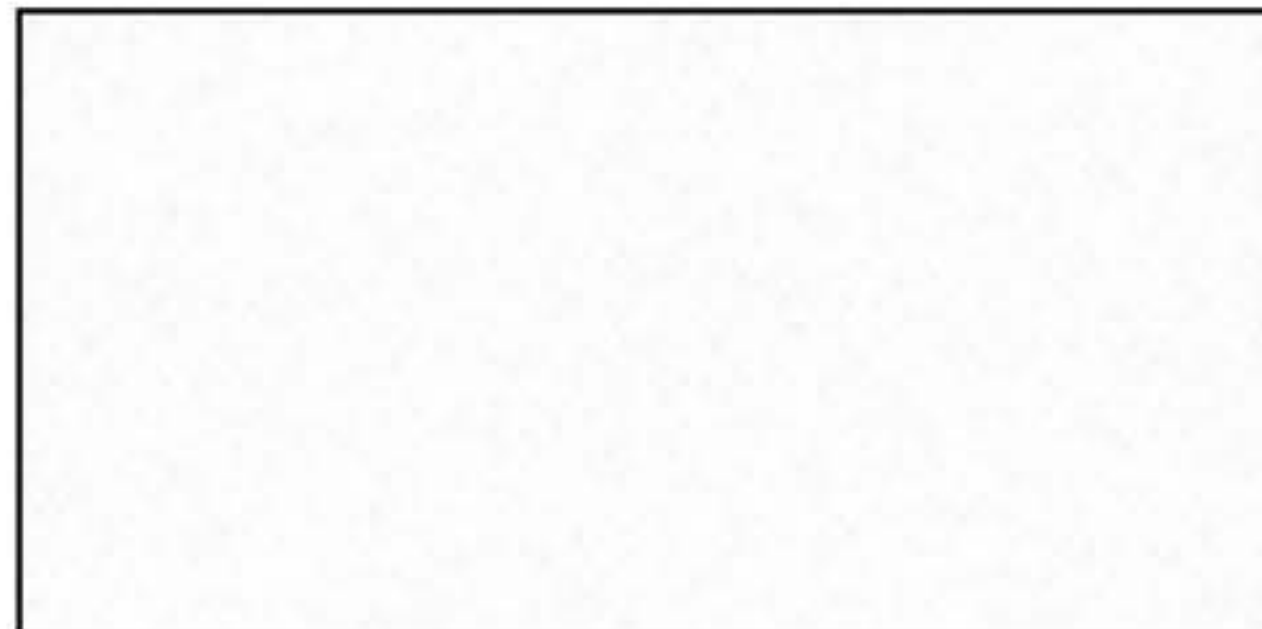

± 9 MM
60X120 (24"X48") FLAMED RET
4D26 LATTE
4D25 VANILLA
4D28 CAMEL
4D27 OYSTER

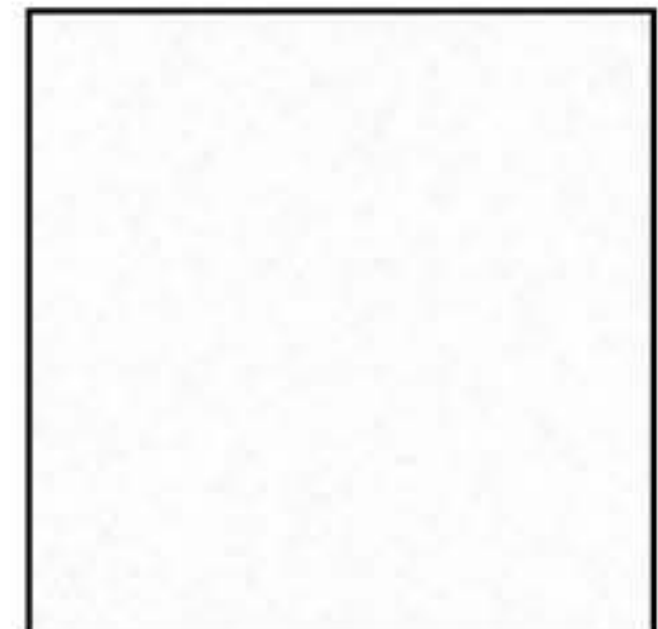

± 9 MM
60X60 (24"X24") FLAMED RET
7W64 LATTE
7X61 VANILLA
7X62 CAMEL
7X63 OYSTER

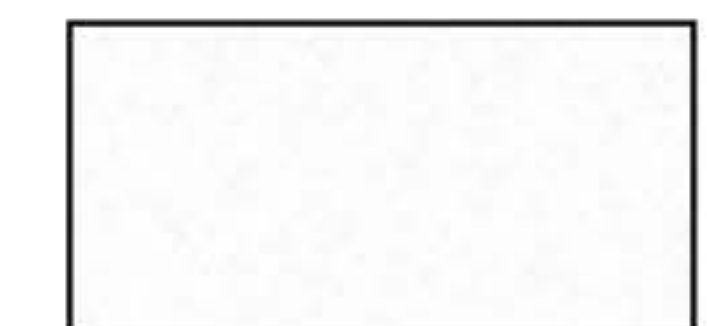

± 9 MM
30X60 (12"X24") FLAMED RET
9H11 LATTE
9H13 VANILLA
9H14 CAMEL
9H15 OYSTER

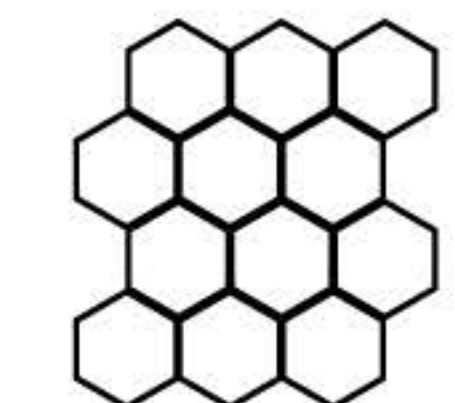

± 9 MM
MOSAICO ESA K96
FOGLIO 29,5X34 (12"X13") ○
NL70 LATTE
NL69 VANILLA
NL68 CAMEL
NL67 OYSTER

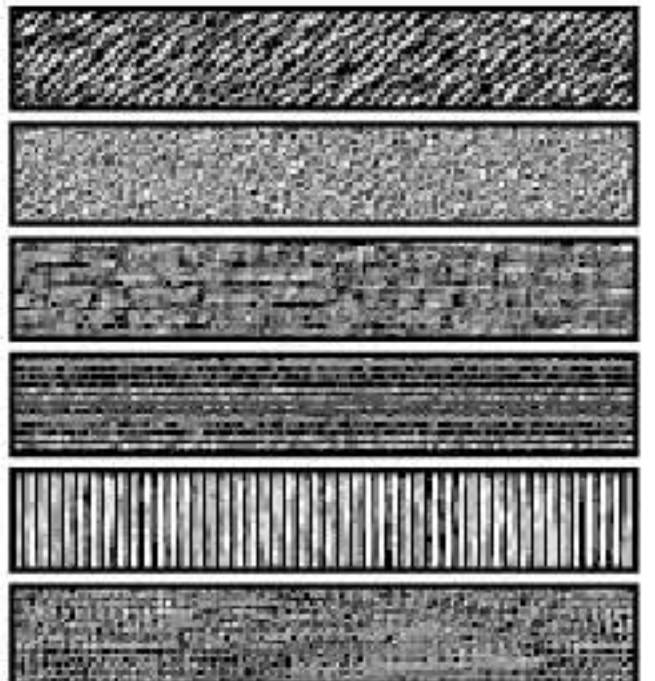

± 9 MM
10X60 (4"X24") ① ★
STUDIO
4FV2 LATTE
4FV3 VANILLA
4FV4 CAMEL
4FV5 OYSTER

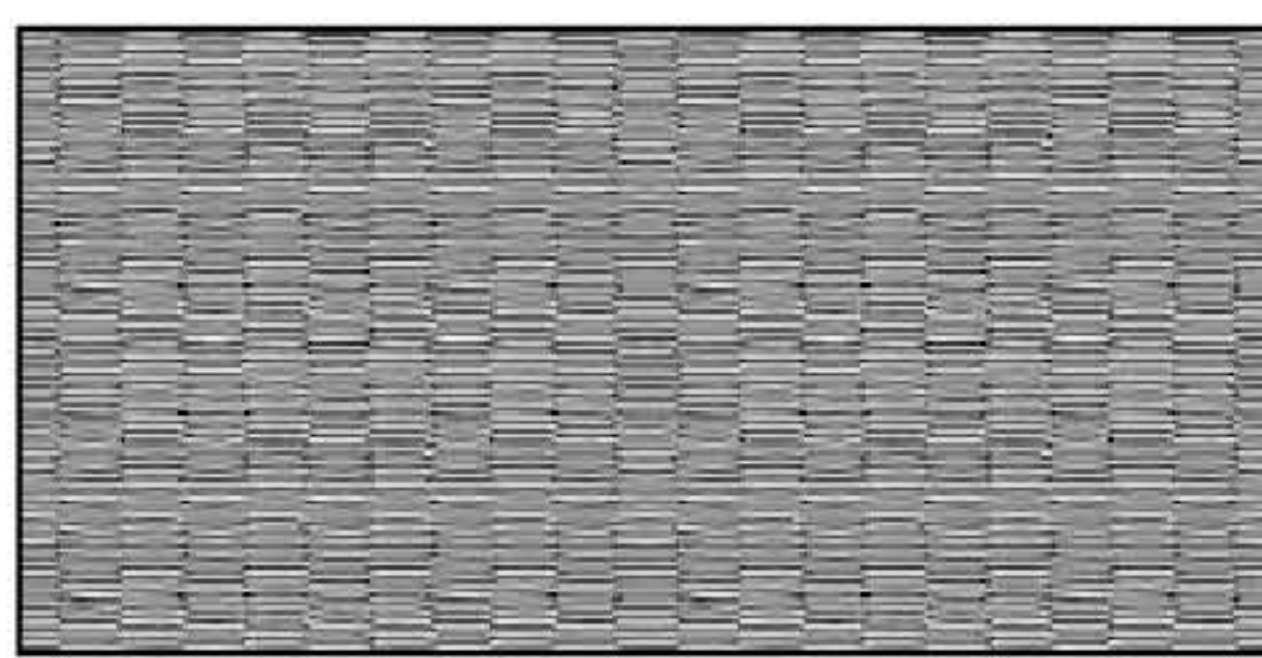

± 9 MM
60X120 (24"X48") SWING RET
4D29 LATTE
4Q12 VANILLA
4Q15 CAMEL
4Q13 OYSTER

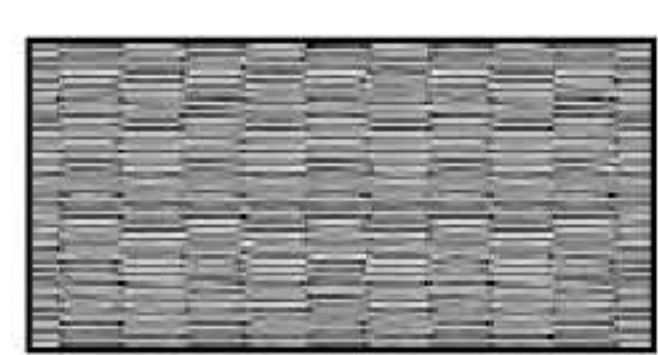

± 9 MM
30X60 (12"X24") SWING RET
9H16 LATTE
9H17 VANILLA
9H18 CAMEL
9H19 OYSTER

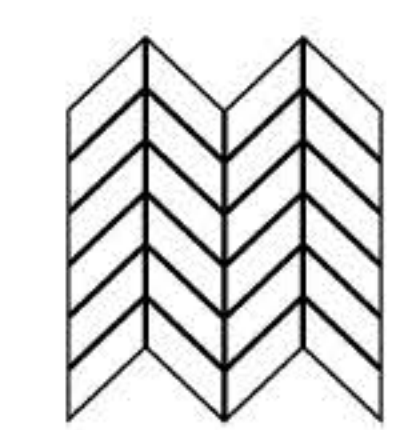

± 9 MM
MOSAICO CHEVRON
FOGLIO 30X31 (12"X12") ○
NL78 LATTE
NL77 VANILLA
NL76 CAMEL
NL75 OYSTER

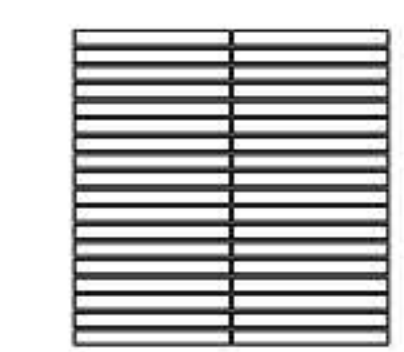

± 9 MM
MOSAICO CRISP
FOGLIO 30X30 (12"X12") ○
NH81 LATTE
NH82 VANILLA
NH83 CAMEL
NH84 OYSTER

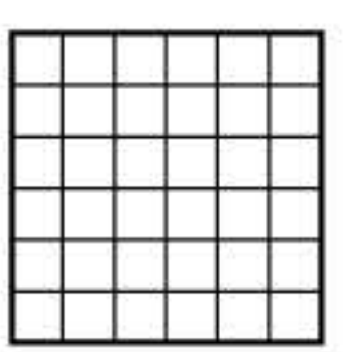

± 9 MM
MOSAICO 5X5 (2"X2")
FOGLIO 30X30 (12"X12") ○
N6D4 LATTE
N6D5 VANILLA
N6D6 CAMEL
N6D7 OYSTER

INFORMAZIONI GENERALI - GENERAL INFORMATION

- Prodotto in porcellanato smaltato con impasti colorati. Superfici naturali e superfici antislip. Bordi rettificati e bordi tagliati. Coloured body glazed porcelain tiles and rectified edges. Natural surfaces and antislip surfaces. Rectified edges and cut edges.
- Tutte le misure sono nominali. Le conversioni in pollici sono approssimate ed arrotondate. All sizes are nominal. The conversions into inches are approximate and rounded off.
- Le confezioni contengono il prodotto con diverse sfumature di tono. Al fine di ottenere il migliore effetto estetico, si consiglia, durante la posa, di prelevare le piastrelle alternativamente da scatole diverse e di posarle in senso ortogonale l'una all'altra. The boxes contain the item with different shade variegations. When you lay down the tiles, in order to obtain the best blend of the colours, we advice you to take the tiles alternatively from different boxes and lay down orthogonally one to the other.
- Per i formati rettangolari consigliamo una posa sfalsata massimo di 1/4 della lunghezza. For the rectangular sizes we suggest an installation pattern at a maximum of 1/4 of the entire length.
- Bordi rettificati: nella posa mono e multi-formato è consigliato prevedere fughe di almeno 2 mm. Rectified edges: when you lay down single and multi sizes it is suggested to use grouts of at least 2 mm.
- Ci riserviamo la facoltà di modificare e/o eliminare i formati, i calibri, gli spessori e le grafiche in qualsiasi momento senza che si renda necessaria una espressa comunicazione scritta. We reserve the right to modify and/or remove the sizes, the calibers, the thickness and the graphics anytime, with no obligation of a further notice in writing.
- I toni degli articoli campionati sono puramente indicativi pertanto le variazioni di tono e di superficie non possono costituire motivo di contestazioni. The shades of the samples are purely representative of the item itself so the shades variation and the surfaces variations cannot constitute the reason for a claim.
- Fondi, decori, mosaici, pezzi speciali o qualsiasi formato da taglio o rettifica, vengono prodotti uno ad uno con interventi manuali ed artigianali durante la fase di lavorazione. Eventuali imperfezioni rientrano nelle tolleranze e non possono essere considerate difetti. Plain tiles, decors, mosaics, special pieces or any item cut or rectified are produced one by one with manual and artisanal interventions during the manufacturing phase. Any possible imperfection is within the tolerances and cannot be considered as a defect/fault.

SIMBOLOGIA - SIMBOLOGY

RET Rettificato Prodotto tagliato Prodotto incollato su rete A richiesta a scatole intere Grafiche miscelate casualmente

Rectified Cut item Item on net On request full boxes Graphics casually mixed

- ① Piastrella con torello incollato (solo su richiesta). Per uso esterno è necessario adottare tutte le misure per una posa a regola d'arte secondo usi e norme in vigore. Tile with glued torello (on request only). For external use it's necessary to adopt all precautions for a perfect tile according to usage and regulations in force.

CARATTERISTICHE TECNICHE - TECHNICAL CHARACTERISTICS

| | Spessore | Formatura del prodotto | Assorbimento d'acqua | Carico di rottura | PEI Resistenza all'abrasione superficiale | Resistenza agli sbalzi termici | Resistenza al gelo | Resistenza chimica | Resistenza alle macchie | Resistenza allo scivolamento | Resistenza allo scivolamento | Coefficiente dinamico di frizione | Resistenza allo scivolamento |
|-----------------|-----------|------------------------|----------------------|------------------------|---|---|---|------------------------------|---|------------------------------|------------------------------|-----------------------------------|--|
| | Thickness | Product Moulding | Water absorption | Modulus of rupture | Resistance to surface abrasion | Resistance to thermal shock | Frost resistance | Chemical resistance | Stain resistance | Slip resistance | Slip resistance | Dynamic coefficient of friction | Slip resistance |
| | | | ISO 10545-3 B 1a | ISO 10545-4 | ISO 10545-7 | ISO 10545-9 | ISO 10545-12 | ISO 10545-13 | ISO 10545-14 | BS EN16165 Annex C | AS/NZS 4586-13 Annex A | DCOF | DIN EN 16165 Annex B DIN EN 16165 Annex A |
| | | | | | | | | | | | | | |
| MYTIME | 9 | RET | < 0,5% | ≥ 43 N/mm ² | 5 | Garantita Guaranteed Garantiert Garantie | Garantita Guaranteed Garantiert Garantie | GA (V) GLA (V) GHA (V) | Conforme Compliant Conforme Konforme | PTV 40 | P3 | > 0,42 | R10 A+B |
| MYTIME Flamed | 9 | RET | < 0,5% | ≥ 43 N/mm ² | 5 | Garantita Guaranteed Garantiert Garantie | Garantita Guaranteed Garantiert Garantie | GA (V) GLA (V) GHA (V) | Conforme Compliant Conforme Konforme | PTV 40 | P4 | > 0,42 | R10 A+B |
| MYTIME Antislip | 9 | RET | < 0,5% | ≥ 43 N/mm ² | 5 | Garantita Guaranteed Garantiert Garantie | Garantita Guaranteed Garantiert Garantie | GA (V) GLA (V) GHA (V) | Conforme Compliant Conforme Konforme | - | - | > 0,70 | R11 A+B+C |

★ ARTICOLO A RICHIESTA A SCATOLE INTERE - ON REQUEST FULL BOXES - LAUT ANFRAGE VOLLE KARTON - SUR DEMANDE BOITES COMPLETES
★ n° 6 grafiche miscelate casualmente - n° 6 graphics casually mixed - n° 6 graphike zufaellig gemischt - n° 6 graphiques mélangées de manière aléatoire